



XTi2 Series Operation Manual

Models: XTi 1002, XTi 2002, XTi 4002, XTi 6002



Obtaining Other Language Versions: To obtain information in another language about the use of this product, please contact your local Crown Distributor. If you need assistance locating your local distributor, please contact Crown at 574-294-8000.

This manual does not include all of the details of design, production, or variations of the equipment. Nor does it cover every possible situation which may arise during installation, operation or maintenance.

The information provided in this manual was deemed accurate as of the publication date. However, updates to this information may have occurred. To obtain the latest version of this manual, please visit the Crown website at www.crownaudio.com.

Trademark Notice: Crown, Crown Audio, and Amcron are registered trademarks of Crown International. Other trademarks are the property of their respective owners. Later versions of this manual and additional information about this product may be available at the Crown website at www.crownaudio.com.

Some models may be exported under the name Amcron®

©2012 by Harman International, 1718 W. Mishawaka Rd., Elkhart, Indiana 46517-9439
U.S.A. Telephone: 574-294-8000.

Important Safety Instructions

1. Read these instructions.
2. Keep these instructions.
3. Heed all warnings.
4. Follow all instructions.
5. Do not use this apparatus near water.
6. Clean only with a dry cloth.
7. Do not block any ventilation openings. Install in accordance with the manufacturer's instructions.
8. Do not install near any heat sources such as radiators, heat registers, stoves, or other apparatus (including amplifiers) that produce heat.
9. Do not defeat the safety purpose of the polarized or ground-type plug. A polarized plug has two blades with one wider than the other. A grounding-type plug has two blades and a third grounding prong. The wide blade or the third prong is provided for your safety. If the provided plug does not fit into your outlet, consult an electrician for replacement of the obsolete outlet.
10. Protect the power cord from being walked on or pinched, particularly at plugs, convenience receptacles, and the point where they exit from the apparatus.
11. Only use attachments/accessories specified by the manufacturer.



12. Use only with a cart, stand, tripod, bracket, or table specified by the manufacturer, or sold with the apparatus. When a cart is used, use caution when moving the cart/apparatus combination to avoid injury from tip-over.

13. Unplug this apparatus during lightning storms or when unused for long periods of time.
14. Refer all servicing to qualified service personnel. Servicing is required when the apparatus has been damaged in any way, such as power-supply cord or plug is damaged, liquid has been spilled or objects have fallen into the apparatus, the apparatus has been exposed to rain or moisture, does not operate normally, or has been dropped.
15. Use the mains plug to disconnect the apparatus from the mains.
16. **WARNING: TO REDUCE THE RISK OF FIRE OR ELECTRIC SHOCK, DO NOT EXPOSE THIS APPARATUS TO RAIN OR MOISTURE.**



17. **DO NOT EXPOSE THIS EQUIPMENT TO DRIPPING OR SPLASHING AND ENSURE THAT NO OBJECTS FILLED WITH LIQUIDS, SUCH AS VASES, ARE PLACED ON THE EQUIPMENT.**

18. **THE MAINS PLUG OF THE POWER SUPPLY CORD SHALL REMAIN READILY OPERABLE.**



TO PREVENT ELECTRIC SHOCK DO NOT REMOVE TOP OR BOTTOM COVERS. NO USER SERVICEABLE PARTS INSIDE. REFER SERVICING TO QUALIFIED SERVICE PERSONNEL.



TO COMPLETELY DISCONNECT THIS EQUIPMENT FROM THE AC MAINS, DISCONNECT THE POWER SUPPLY CORD PLUG FROM THE AC RECEPTACLE. THE MAINS PLUG OF THE POWER SUPPLY CORD SHALL REMAIN READILY OPERABLE.

WATCH FOR THESE SYMBOLS:



The lightning bolt triangle is used to alert the user to the risk of electric shock.



The exclamation point triangle is used to alert the user to important operating or maintenance instructions.



IMPORTANT

XTi Series amplifiers require Class 2 output wiring.

MAGNETIC FIELD

CAUTION! Do not locate sensitive high-gain equipment such as preamplifiers or tape decks directly above or below the unit. Because this amplifier has a high power density, it has a strong magnetic field which can induce hum into unshielded devices that are located nearby. The field is strongest just above and below the unit.

If an equipment rack is used, we recommend locating the amplifier(s) in the bottom of the rack and the preamplifier or other sensitive equipment at the top.

FCC COMPLIANCE NOTICE

This device complies with part 15 of the FCC rules. Operation is subject to the following two conditions: (1) This device may not cause harmful interference, and (2) this device must accept any interference received, including interference that may cause undesired operation.

CAUTION: Changes or modifications not expressly approved by the party responsible for compliance could void the user's authority to operate the equipment.

NOTE: This equipment has been tested and found to comply with the limits for a Class B digital device, pursuant to part 15 of the FCC Rules. These limits are designed to provide reasonable protection against harmful interference in a residential installation. This equipment generates, uses, and can radiate radio frequency energy and, if not installed and used in accordance with the instruction manual, may cause harmful interference to radio communications. However, there is no guarantee that interference will not occur in a particular installation. If this equipment does cause harmful interference to radio or television reception, which can be determined by turning the equipment off and on, the user is encouraged to try to correct the interference by one or more of the following measures:

- Reorient or relocate the receiving antenna.
- Increase the separation between the equipment and receiver.
- Connect the equipment into an outlet on a circuit different from that to which the receiver is connected.
- Consult the dealer or an experienced radio/TV technician for help.

DECLARATION OF CONFORMITY

Issued By: Harman International.
1718 W. Mishawaka Rd.
Elkhart, IN 46517 U.S.A.

FOR COMPLIANCE Sue Whitfield
QUESTIONS ONLY: Sue.Whitfield@harman.com

European Representative's Name and Address:

David Budge
10 Harvest Close
Yateley, GU46 6YS
United Kingdom

Equipment Type: Commercial Audio Power Amplifiers

Family Name: XTi2 Series

Model Names: XTi 1002, XTi 2002, XTi 4002, XTi 6002

EMC Standards:

EN 55103-1:2009 EMC Compatibility – Product Family Standard for Audio, Video, Audio-Visual and Entertainment Lighting Control Apparatus for Professional Use, Part 1: Emissions

EN 55103-1:2009 Magnetic Field Emissions – Annex A @ 10cm and 1M

EN 61000-3-2:2006 Limits for Harmonic Current Emissions (equipment input current less than or equal to 16A)

EN 61000-3-3:2008 Limitation of Voltage Fluctuations and Flicker in Low-Voltage Supply systems Rated Current less than or equal to 16A

EN 55022:2010 Limits and Methods of Measurement of Radio Disturbance Characteristics of ITE: Radiated & Conducted, Class B Limits

EN 55103-2:2009 EMC Compatibility – Product Family Standard for Audio, Video, Audio-Visual and Entertainment Lighting Control Apparatus for Professional Use, Part 2: Immunity

EN 61000-4-2:2008 Ed 2.0 Electrostatic Discharge Immunity (Environment E2-Criteria B, 4k V Contact, 8k V Air Discharge)

EN 61000-4-3:2010 Ed 3.2 Radiated, Radio-Frequency, EMC Immunity (Environment E2, Criteria A)

EN 61000-4-4:2007 Electrical Fast Transient/Burst Immunity (Criteria B)

EN 61000-4-5:2006 Surge Immunity (Criteria B)

EN 61000-4-6:2006 Immunity to Conducted Disturbances Induced by Radio-Frequency Fields (Criteria A)

EN 61000-4-11:2004 Voltage Dips, Short Interruptions and Voltage Variation

Safety Standard:

IEC 60065: 2001Ed 7 +A1:2005 Safety Requirements – Audio, Video, and Similar Electronic Apparatus

CAN/CSA 60065-03 incl. A1 Safety Requirements – Audio, Video, and Similar Electronic Apparatus

UL Std No. 60065-2007 Safety Requirements – Audio, Video, and Similar Electronic Apparatus

I certify that the product identified above conforms to the requirements of the EMC Council directive 2004/108/EC and the Low Voltage Directive 2006/95/EC.

Signed



Terry Davenport
Senior Director of Operations

Date of Issue: February 1, 2012

Due to line current harmonics, we recommend that you contact your supply authority before connection.

Get Started

Stereo DSP Off

This is the default mode the amplifier is set to from the factory. The amplifier is configured for stereo mode with all processing disabled.

1. Connect Left/Right signal source to Channel 1 and Channel 2 using the XLR connectors.
2. Connect a speaker to each channel output using Speakon®, Banana Plugs, or bare wire.

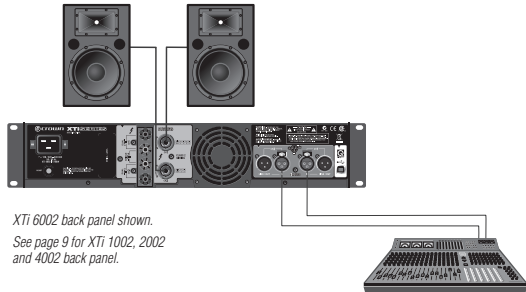

Factory Preset #2: BRIDGE

Putting the amplifier in **BRIDGE** (bridge-mono) mode delivers the power of both amp channels into a **single** 8 or 4 ohm load. The XTi2 Series amplifiers come pre-loaded with a preset that makes it easy to configure the amplifier for this operation.

Before you get started ensure that you:

1. Connect signal source to Channel 1 and Channel 2 using XLR connectors (the amplifier inputs will automatically be summed together when selecting this preset).
2. Connector the speaker as shown.
 - a. If using the binding post outputs, connect the positive terminal of the speaker to the positive terminal of Channel 1 and the negative terminal of the speaker to the positive terminal of Channel 2.
 - b. If using a Speakon® connector, connect the positive terminal of the speaker to 1+ and the negative terminal to 2+. Plug the connector into the Channel 1 output only.

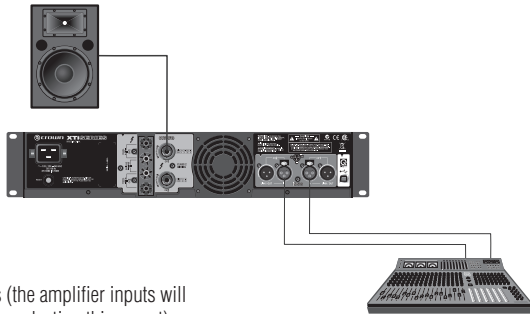

NOTE: Custom wiring should only be performed by qualified personnel.

Follow these quick steps to configure the amplifier for **BRIDGE** operation:

1. Push the "Set/Enter" button and you will see the word "Preset" flashing.
2. Push the "Set/Enter" button again to enter the list of presets in the amplifier.
3. Push the "Next/Down" or "PREV/UP" button until the screen displays "Bridge".
4. Push the "Set/Enter" button to confirm your selection.
5. The display will now read "Bridge" with the Y icon and Bridge icon highlighted.

Get Started

Factory Preset #3: XOVER

Putting the amplifier in **XOVER** mode enables a 1.2kHz 4th order (24dB/octave) filter that sends frequencies of 1.2kHz and below to Channel 1 output and frequencies of 1.2kHz and above to Channel 2 output. The XTi2 Series amplifiers come pre-loaded with a preset that makes it easy to configure the amplifier for this operation.

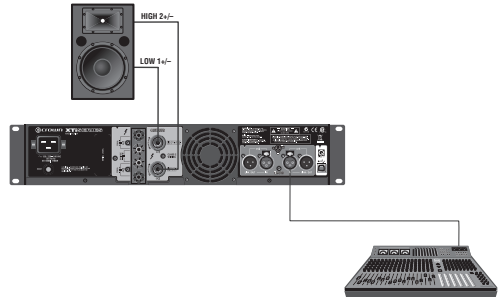

Before you get started ensure that you:

1. Connect signal source to Channel 1 **ONLY** using an XLR connector (the amplifier inputs will automatically be put into Y mode when selecting this preset).
2. Connector the speaker as shown.
 - a. Connect the speaker you wish to receive the low and mid frequencies (1.2kHz and below) to Channel 1 output using Speakon®, Banana Plugs, or bare wire.
 - b. Connect the speaker you wish to receive the high frequencies (1.2kHz and above) to Channel 2 output using Speakon®, Banana Plugs, or bare wire.

Follow these quick steps to configure the amplifier for “Crossover Mode”:

1. Push the “Set/Enter” button and you will see the word “Preset” flashing.
2. Push the “Set/Enter” button again to enter the list of presets in the amplifier.
3. Push the “Next/Down” or “PREV/UP” button until the screen displays “BIAMP”.
4. Push the “Set/Enter” button to confirm your selection.
5. The display will now read “BIAMP” with the Y icon and XOV icon highlighted.

Get Started

Factory Preset #4: BRG SUBS

Putting the amplifier in **BRG SUBS** (bridged subs) mode allows you to bridge the amplifier for use with a single 8 or 4 ohm subwoofer. The inputs are automatically summed, a 90Hz 4th order (24dB/octave) LowPass filter is enabled, and the output mode is put into bridge-mono mode. The XTi2 Series amplifiers come pre-loaded with a preset that makes it easy to configure the amplifier for this operation.

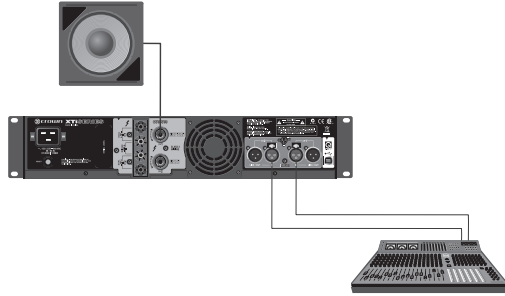

Before you get started ensure that you:

1. Connect signal source to Channel 1 and Channel 2 using XLR connectors (the amplifier inputs will automatically be summed together when selecting this preset).
2. Connector the speaker as shown.
 - a. If using the binding post outputs, connect the positive terminal of the speaker to the positive terminal of Channel 1 and the negative terminal of the speaker to the positive terminal of Channel 2.
 - b. If using a Speakon® connector, connect the positive terminal of the speaker to 1+ and the negative terminal to 2+. Plug the connector into the Channel 1 output only.

Follow these quick steps to configure the amplifier for **XOVER** operation:

1. Push the "Set/Enter" button and you will see the word "Preset" flashing.
2. Push the "Set/Enter" button again to enter the list of presets in the amplifier.
3. Push the "Next/Down" or "PREV/UP" button until the screen displays "XOVER".
4. Push the "Set/Enter" button to confirm your selection.
5. The display will now read "XOVER" with the Y icon and XOV icon highlighted.

Get Started

Factory Preset #5: SUBSYNTH

Putting the amplifier in **SUBSYNTH** mode allows you to turn on the SubHarmonic Synth feature for use with a subwoofer on both channels. The inputs are automatically summed, a 90Hz 4th order (24dB/octave) filter is enabled on both Channel 1 and Channel 2, and the SubHarmonic Synth feature is turned on at +12dB level. The XTi2 Series amplifiers come pre-loaded with a preset that makes it easy to configure the amplifier for this operation.

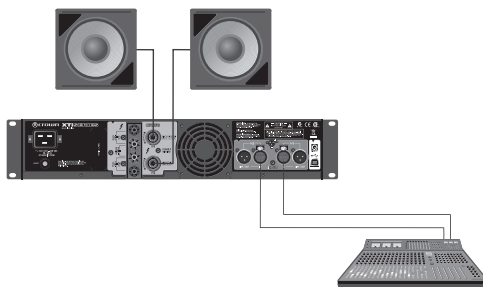

Before you get started ensure that you:

1. Connect signal source to Channel 1 and Channel 2 using XLR connectors (the amplifier inputs will automatically be summed together when selecting this preset).
2. Connector the speaker as shown.
 - a. Connect a speaker to each channel output using Speakon®, Banana Plugs, or bare wire

Follow these quick steps to configure the amplifier for **SUBSYNTH** operation:

1. Push the “Set/Enter” button and you will see the word “Preset” flashing.
2. Push the “Set/Enter” button again to enter the list of presets in the amplifier.
3. Push the “Next/Down” or “PREV/UP” button until the screen displays “SUBSYNTH”.
4. Push the “Set/Enter” button to confirm your selection.
5. The display will now read “SUBSYNTH” with the Y icon and XOY icon highlighted.

Ensure Proper Cooling

When using an equipment rack, mount units directly on top of each other. Close any open spaces in rack with blank panels. DO NOT block front or rear air vents. The side walls of the rack should be a minimum of two inches (5.1 cm) away from the amplifier sides, and the back of the rack should be open.



CAUTION: Before you begin installing your amplifier, make sure it is disconnected from the power source, with the power switch in the “off” position and all level controls turned completely down (counterclockwise).

Front Panel Features

Indicators:

Ready Indicator: Two green LEDs, one for each channel, illuminate when the amplifier is ready to produce audio.

Signal Presence Indicator: Two green LEDs, one for each channel, illuminate when the channel input exceeds -40dBu. Useful for troubleshooting cable runs.

-20 Indicator: Two green LEDs, one for each channel, illuminate when the output signal exceeds -20dB below clip.

-10 Indicator: Two green LEDs, one for each channel, illuminate when the output signal exceeds -10dB below clip.

Clip Indicator: Two red LEDs, one for each channel, illuminate at the threshold of audible distortion.

Thermal Indicator: Two red LEDs, one for each channel, illuminate when thermal compression begins due to excessive temperature conditions.

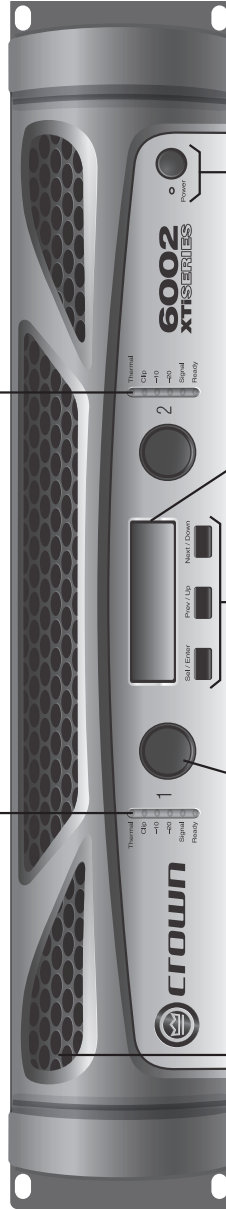

Cooling Vents:

Front to rear forced air flow.

Gain (Level) Controls:

Two black rotary level controls, one for each channel.

LCD Screen:

Backlit liquid crystal display shows enabled presets and speaker processing.

Power Button & Indicator:

Turns amplifier power on and off. Blue LED will illuminate when power is turned on.

Sel/Prev/Next Buttons:

Three buttons located underneath the LCD screen used to access menu items and front panel lockout.

WARNING: Never connect the output to a power supply, battery or power main. Electrical shock may result.



Back Panel Features

XTi 1002, 2002, 4002

Binding Post Output Jacks:

One pair per channel, accepts banana plugs or bare wire. Note: Binding Post outputs on European models come with safety plugs installed to prevent European power plugs from being inserted. The side entry positions for these connectors should be used with European models.

Power Cord Clip:

Mounting points for securing, included power cord clip.

Fans:

Provide front to back forced airflow for cooling.

Input Connector:

Two 3-pin XLR input connectors are provided (one per channel).

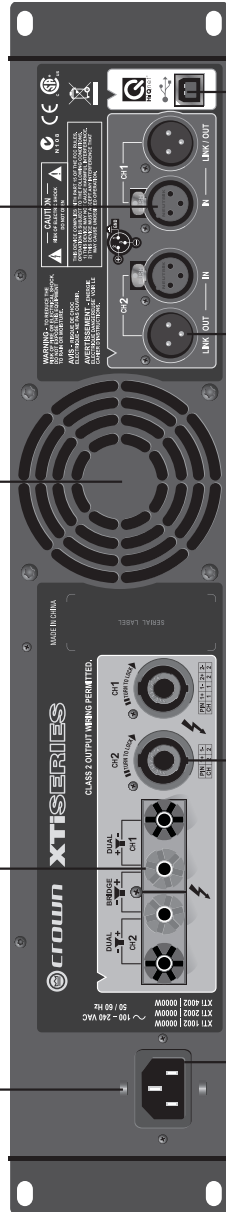

AC Power Connector

4-Pole Speaker® Output Connectors:

These two connectors accept 2-pole and 4-pole Speakon® connectors. The channel 1 connector is wired for both channels so it can be used for bridge-mono wiring or stereo wiring of two speakers to a single Speakon.

Link/Out Connector:

Two 3-pin XLR output connectors are provided (one per channel) to loop-thru signal from one amplifier to another.

HiQnet USB Connector:

Type B USB connector allows you to connect the amplifier to a computer for use with System Architect™ and Band Manager™ software.

Front Panel Navigation

From the front panel, you can change settings for several of the amplifier's integrated signal processing features: Input Y, Crossover Frequency, EQ, Delay, Limiting, and Stereo/Bridge-Mono. The icons in the display illuminate to show which features are currently applied and turned on.

When you power-on the amplifier for the first time, the LCD screen displays "DSP OFF" (no DSP is applied). Subsequent power-ons display the preset that was active when you last shut off the amplifier.

The figure below shows the Menu Tree, which is the navigation path of options in the Menu. It shows how you navigate through the front panel and which settings are available from the front panel. For full access to all features, it is required that you hook up the amplifier via USB to a computer and run either HiQnet System Architect™ or Band Manager™ software. Both are available free via download from the following address: <http://hiqnet.harmanpro.com>.

Menu Tree

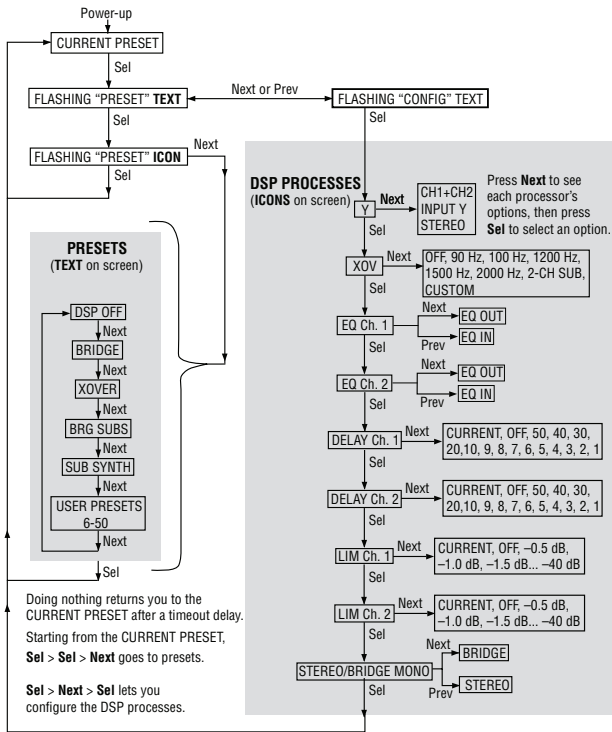

Navigating the LCD Screen Menu: Basics

To step through the Menu options, press the **Sel**, **Next** or **Prev** buttons as described in the menu tree above. Icons illuminated at the top of the screen show which DSP functions are active with the current preset.

When you are modifying a preset, its icon flashes. You can scroll through its settings with the **Prev** and **Next** buttons. When you see the desired setting, select it by pressing Sel. Doing nothing returns you to the current preset after ten seconds.

In the LCD screen, if the Preset Icon is lit, the current preset is unchanged from its stored settings. If the Custom Icon is lit, the current preset has been changed from its stored settings.

Integrated Processing Features

The XTi2 Series amplifiers include a number of integrated processing features which appear as icons on the front panel LCD screen. They are described below:

NOTE: System Architect Software is required to have full control over all Integrated Processing Features which can be downloaded from the following URL – <http://hiqnet.harmanpro.com/>. When controlling more than one XTi2 at a time you will need USB Hub. We recommend using a Powered USB Hub.

Input Mode

- Stereo – In this mode, Channel 1 input goes to Channel 1 output and Channel 2 input goes to Channel 2 output. This is the mode the amplifier is configured for from the factory.
- SUM (CH1 + CH2) – In this mode, the Channel 1 input signal and Channel 2 input signal are summed and fed to both output channels. This provides a 6 dB level boost.
- Input Y – In this mode, the Channel 1 input signal is sent to the Channel 1 and Channel 2 output. The channel 2 input signal is ignored.

Output Mode

- Stereo – In this mode, the amplifier sends Channel 1 input signal to the Channel 1 output and the Channel 2 input signal to the Channel 2 output.
- Bridge-Mono – In this mode, the power of both amplifier channels are delivered into a single 8 or 4 ohm load.

Subharmonic Synth

The Subharmonic Synth feature takes the low frequencies and “synthesizes” or creates new frequencies that are one octave lower. The two signals are then summed together. Also new, are two user adjustable parametric EQ filters and crossover frequency filter. These can be used to “shape” the sound and enhance the desired effect.

Equalization

The XTi2 Series provides two blocks of equalization in the signal processing. The input EQ block is before the crossover and is usually used for the room EQ. The output EQ block is after the crossover and is usually used for speaking tuning.

Input EQ: This input EQ block provides 6 filters per channel each with frequency, gain, and Q that is user controllable. This block also has a High and Low Shelf Filter per channel which has gain and frequency control.

Output EQ: This output EQ block provides 8 filters per channel each with frequency, gain, and Q control that is user controllable.

Crossover:

The crossover section provides users with the ability to enable a HighPass and LowPass filter per channel along with BandPass gain and the ability to change the polarity. This allows the Crossover section to be customized to most system configurations.

For the HighPass and LowPass Filters, you have the choice of the following filters: Butterworth 6dB/oct, Butterworth 12dB/oct, Butterworth 18dB/oct, Butterworth 24dB/oct, Butterworth 48dB/oct, Linkwitz-Riley 24dB/oct, and Linkwitz-Riley 48dB/oct.

The BandPass gain provides you with -15dB to +15dB of gain.

Integrated Processing Features

Delay

There is up to 50msec of delay available in the signal processing for time aligning your speakers. The software allows you to enter the amount of delay needed in the form of seconds, feet, or meters and does the calculation for you.

Peak χ Plus Limiter:

Feed-forward output limiter with user-adjustable attack, release and threshold (0.1 dB resolution), plus integrated feedback limiter to minimize amplifier clipping.

Advanced Thermal Control

In this section, you can tailor the fan speed to specific applications. You have the choice of the following modes:

- Normal
- Early
- Full-Speed

The fan mode can be changed using the front panel buttons at start-up or in the software. The default mode is normal and should work fine for most applications. Early mode turns the fan on sooner at a "lower" temperature, and Full-speed mode turns the fan on full-speed full-time. Full-speed mode is not recommended for "dirty" environments.

Advanced Monitoring

This feature allows you to have software visibility of both the Power Supply Temperature and AC Line voltage. AC Line voltage is "derived" from the amplifier rail voltage and is an approximation of the AC line voltage. This allows you to monitor the health of your amplifiers and provides for troubleshooting.

Front Panel Lock-Out

To disable or lock the buttons from the front panel, hold the Prev and Next at the same time until the screen says "locked". The rotary knobs (attenuators) will still operate. To unlock, hold Prev and Next until the screen says "unlocked".

The front panel can also be locked out from the software as well from the main panel. However once it is locked in the software, it can only be unlocked from the software. You cannot unlock from the front panel. **The rotary knobs (attenuators) will still operate.**

XTi Specifications

Minimum Guaranteed Power, 1 kHz	XTi 1002	XTi 2002	XTi 4002	XTi 6002
Per channel, both channels driven				
Stereo, 2 ohms (per channel)	700W	1,000W	1,600W	3,000W
Stereo, 4 ohms (per channel)	500W	800W	1,200W	2,100W
Stereo, 8 ohms (per channel)	275W	475W	650W	1,200W
Bridge-Mono, 4 ohms	1,400W	2,000W	3,200W	6,000W
Bridge-Mono, 8 ohms	1,000W	1,600W	2,400W	4,200W

With 0.5% THD. *With 1% THD. † Not rated for 100V versions.

Performance

Sensitivity (volts RMS) for full rated power at 4 ohms: 1.4 V.

Frequency Response (at 1 watt into 4 ohms, 20 Hz to 20 kHz): +0 dB, -1 dB.

Signal to Noise Ratio (below rated 1 kHz power at 8 ohms), A-weighted: 100 dB (103 dB in XTi 6000).

Damping Factor (8 ohm) 10 Hz to 400 Hz: > 500.

Crosstalk (below rated power) 20 Hz to 1 kHz: > 70 dB.

Input Impedance (nominal): 20 kilohms balanced, 10 kilohms unbalanced.

Input Stage: Input is electronically balanced and employs precision 1% resistors.

AC Line Current (120VAC amplifier playing 1/8 power pink noise into 4 ohms per ch):

XTi 1002: 6.8A, XTi 2002: 8.3A, XTi 4002: 10.5A; at idle draws no more than 30 watts.

XTi 6002: 15.3A; at idle draws no more than 180 watts.

Voltage Gain (at 1 kHz, 8 ohm rated output): XTi 1002: 30.5 dB. XTi 2002: 32.9 dB. XTi 4002: 34.2 dB.

XTi 6002: 37.1 dB.

Maximum Input Signal: +22 dBu typical.

XTi Specifications

Load impedance (note: safe with all types of loads)

Stereo: 2-8 ohms (4-8 ohms in XTi 1000 A1 100V versions).

Bridge-Mono: 4-16 ohms (8-16 ohms in XTi 1000 A1 100V versions).

AC Line Voltage and Frequency Configurations Available ($\pm 10\%$): 100V, 120V, 220-240V 50/60 Hz.

Operating Temperature: 0° C to 40° C at 95% relative humidity (non-condensing).

Construction

Ventilation: Flow-through ventilation from front to back.

Cooling: Heat sinks and proportional-speed fan.

Dimensions. Width, Height, Depth (behind mounting surface):

EIA Standard 19 in. W (EIA RS-310-B) x 3.5 in. (8.9 cm) H x 12.25 in. (31.1cm) D. XTi 6000 is 16.2 in. (41.15 cm) D.

Weight

Net Weight, Shipping Weight: 18.5 lb (8.4 kg), 21.5 lb (9.8 kg). XTi 6002 is 24.0 lb (10.9 kg), 30.0 lb (13.6 kg).

Warranty

SUMMARY OF WARRANTY

Crown International, 1718 West Mishawaka Road, Elkhart, Indiana 46517-4095 U.S.A. warrants to you, the ORIGINAL PURCHASER and ANY SUBSEQUENT OWNER of each NEW Crown product, for a period of three (3) years from the date of purchase by the original purchaser (the "warranty period") that the new Crown product is free of defects in materials and workmanship. We further warrant the new Crown product regardless of the reason for failure, except as excluded in this Warranty.

**Warranty is only valid within the United States of America. For information on Warranty outside of the U.S.A, please contact your local distributor.*

ITEMS EXCLUDED FROM THIS CROWN WARRANTY

This Crown Warranty is in effect only for failure of a new Crown product which occurred within the Warranty Period. It does not cover any product which has been damaged because of any intentional misuse, accident, negligence, or loss which is covered under any of your insurance contracts. This Crown Warranty also does not extend to the new Crown product if the serial number has been defaced, altered, or removed.

WHAT THE WARRANTOR WILL DO

We will remedy any defect, regardless of the reason for failure (except as excluded), by repair, replacement, or refund. We may not elect refund unless you agree, or unless we are unable to provide replacement, and repair is not practical or cannot be timely made. If a refund is elected, then you must make the defective or malfunctioning product available to us free and clear of all liens or other encumbrances. The refund will be equal to the actual purchase price, not including interest, insurance, closing costs, and other finance charges less a reasonable depreciation on the product from the date of original purchase. Warranty work can only be performed at our authorized service centers or at the factory. Warranty work for some products can only be performed at our factory. We will remedy the defect and ship the product from the service center or our factory within a reasonable time after receipt of the defective product at our authorized service center or our factory. All expenses in remedying the defect, including surface shipping costs in the United States, will be borne by us. (You must bear the expense of shipping the product between any foreign country and the port of entry in the United States including the return shipment, and all taxes, duties, and other customs fees for such foreign shipments.)

HOW TO OBTAIN WARRANTY SERVICE

You must notify us of your need for warranty service within the warranty period. All components must be shipped in a factory pack, which, if needed, may be obtained from us free of charge. Corrective action will be taken within a reasonable time of the date of receipt of the defective product by us or our authorized service center. If the repairs made by us or our authorized service center are not satisfactory, notify us or our authorized service center immediately.

DISCLAIMER OF CONSEQUENTIAL AND INCIDENTAL DAMAGES

YOU ARE NOT ENTITLED TO RECOVER FROM US ANY INCIDENTAL DAMAGES RESULTING FROM ANY DEFECT IN THE NEW CROWN PRODUCT. THIS INCLUDES ANY DAMAGE TO ANOTHER PRODUCT OR PRODUCTS RESULTING FROM SUCH A DEFECT. SOME STATES DO NOT ALLOW THE EXCLUSION OR LIMITATIONS OF INCIDENTAL OR CONSEQUENTIAL DAMAGES, SO THE ABOVE LIMITATION OR EXCLUSION MAY NOT APPLY TO YOU.

WARRANTY ALTERATIONS

No person has the authority to enlarge, amend, or modify this Crown Warranty. This Crown Warranty is not extended by the length of time which you are deprived of the use of the new Crown product. Repairs and replacement parts provided under the terms of this Crown Warranty shall carry only the unexpired portion of this Crown Warranty.

DESIGN CHANGES

We reserve the right to change the design of any product from time to time without notice and with no obligation to make corresponding changes in products previously manufactured.

LEGAL REMEDIES OF PURCHASER

THIS CROWN WARRANTY GIVES YOU SPECIFIC LEGAL RIGHTS, YOU MAY ALSO HAVE OTHER RIGHTS WHICH VARY FROM STATE TO STATE. No action to enforce this Crown Warranty shall be commenced after expiration of the warranty period.

THIS STATEMENT OF WARRANTY SUPERSEDES ANY OTHERS CONTAINED IN THIS MANUAL FOR CROWN PRODUCTS. 07/12

