

F4 D PO IP

POLE-OPERATED DAYLIGHT FRESNEL SPOTLIGHT - IP65



FEATURES

- ▶ Fresnel spotlight with daylight LED, 5,600 K
- ▶ 30,000 lm luminous flux replaces conventional 2kW halogen Fresnel spotlights
- ▶ IP65-certified for permanent outdoor use
- ▶ Pole-operated for efficient use in different environments (TV studios, etc.)
- ▶ Natural color reproduction (CRI: 94, TLCI: 96)
- ▶ Continuous zoom range from 14° to 43°
- ▶ Flicker-free camera images thanks to selectable pulse width modulation frequencies up to 25 kHz
- ▶ Selectable 16-bit dimmer curves for smooth dimming
- ▶ 8-way barn door and color filter frame included
- ▶ Highly efficient cooling system and silent mode for noise-free operation

DESCRIPTION

It can be challenging with ever-changing weather conditions to do concerts or film & TV productions outdoors. In order to still rely on the natural daylight of a zoomable Fresnel spotlight here, there's the dust- and splash water-protected, IP65-certified F4 D PO IP spotlight by Cameo. It is pole-operated making it easy to adjust from the ground.

The F4 D PO IP from the Cameo F Series is a natural light specialist with a CRI value of 95 and a TLCI of 94. The precise 250 mm Fresnel glass lens with a continuous zoom lets you keep control over the 30,000 lm white light, whether you use it to shine the spotlight right down on performers, speakers or objects or apply it as area lighting for entire scenes and surfaces.

The F4 D PO IP is a low-maintenance, pole-operated LED daylight spotlight with clear daylight reproduction, which remains fully usable even outdoors, thanks to IP65 - a real work relief for fast and natural illumination.



Features and specifications
subject to change without notice.

adamhall.com

F4 D PO IP

POLE-OPERATED DAYLIGHT FRESNEL SPOTLIGHT - IP65



TECHNICAL DRAWING

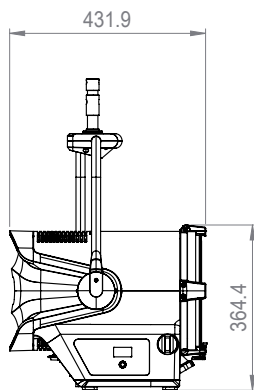
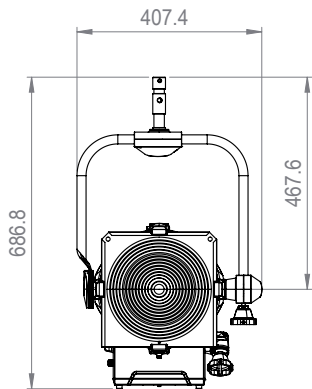

SPECIFICATIONS

Product type	LED Fresnel Spotlight
Type	Outdoor, Theater Fresnel
Color spectrum	Daylight
Color temperature	5600 K
Number of LEDs	1
LED type	520 W (approx. 50,000 operating hours)
LED PWM Frequency	600 Hz, 1200 Hz, 2000 Hz, 4000 Hz, 6000 Hz, 25000 Hz, adjustable
Dispersion	Beam Angle: 14 - 43 °, Field Angle: 24 - 57 °
Lens	250 mm Fresnel
DMX input	5-Pol
DMX output	5-Pol
DMX Functions	Device Settings, Dimmer, Dimmer Curve, Dimmer Fine, strobe
Standalone modes	Master / Slave mode, Static
Controls	Push encoder
Indicators	OLED Display
Operating voltage	100 V AC - 240 V AC, 50 - 60 Hz
Power consumption	460 W
Power connector	TRUE1 Compatible Power I/O Socket
Power supply connection	TRUE1 compatible Power I/O sockets
Housing material	Die-cast aluminium
Cabinet color	Black
Protection class IP	65
CRI	94
Cooling	Heat-pipe cooling system with temperature controlled fans
Luminous flux	30000 lm
Efficiency	54 lm/W
Operating Temperature	-15 - 45 °C

Dimensions without Mounting Bracket

Width	433 mm
Height	420 mm
Length	531 mm
Weight	25 kg

PHOTOMETRICAL DATA

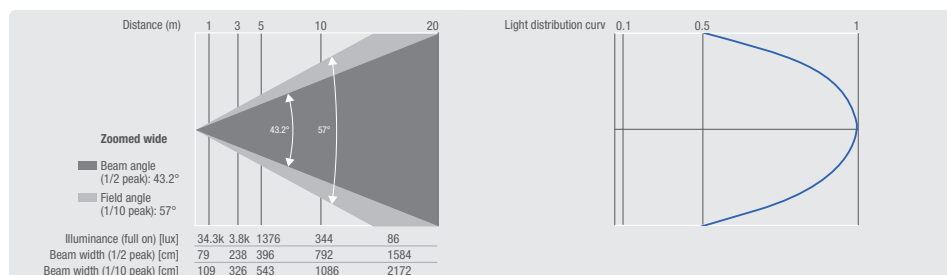
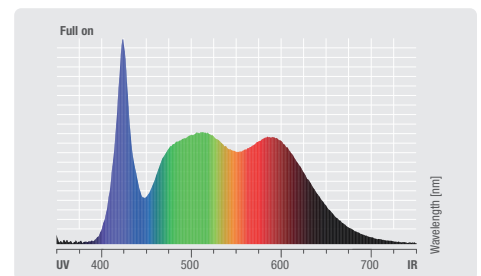
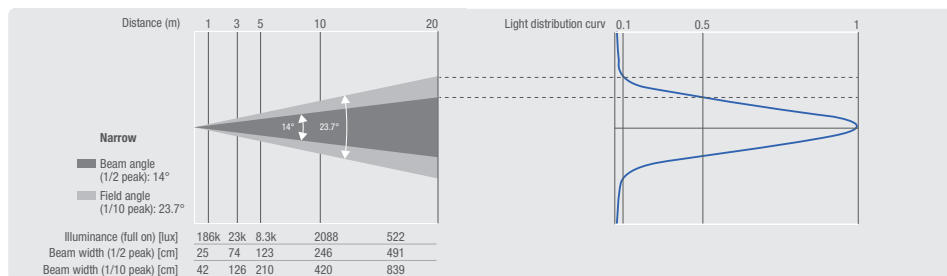

Features and specifications subject to change without notice.

adamhall.com