

TASCAM

LA207G0001

MA-BT240

INSTALLATION AMPLIFIER

OWNER'S MANUAL

ENGLISH

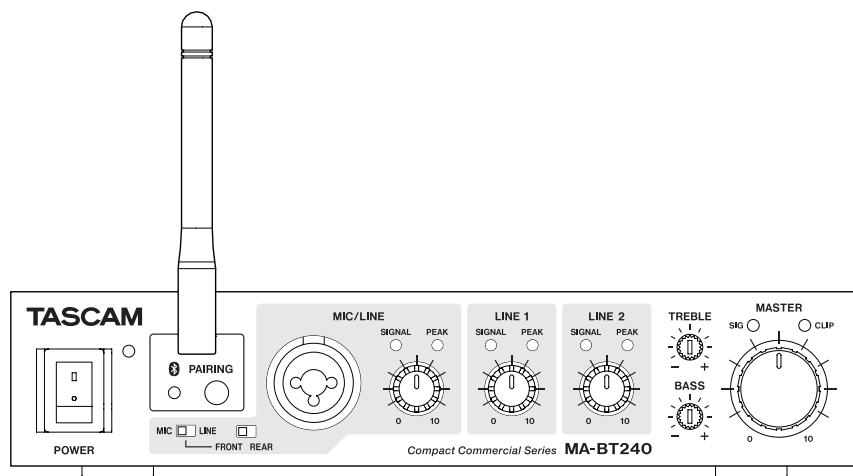

TASCAM

TEAC CORPORATION

Phone: +81-42-356-9143

1-47 Ochiai, Tama-shi, Tokyo 206-8530 Japan

<https://tascam.jp/jp/>

TEAC AMERICA, INC.

Phone: +1-323-726-0303

10410 Pioneer Blvd., Unit #3, Santa Fe Springs, California 90670, U.S.A

<https://tascam.com/us/>

TEAC UK Ltd.

Phone: +44-1923-797205

Luminous House, 300 South Row, Milton Keynes, Buckinghamshire, MK9 2FR, UK

<https://www.tascam.eu/en/>

TEAC EUROPE GmbH

Phone: +49-611-71580

Bahnstrasse 12, 65205 Wiesbaden-Erbenheim, Germany

<https://www.tascam.eu/de/>





TEAC SALES & TRADING(SHENZHEN) CO., LTD

Phone: +86-755-88311561~2

Room 817, Xinian Center A, Tairan Nine Road West, Shennan Road, Futian District, Shenzhen, Guangdong Province 518040, China

<https://tascam.cn/cn/>

IMPORTANT SAFETY INSTRUCTIONS

 <div style="border: 1px solid black; padding: 2px; display: inline-block; text-align: center;"> CAUTION <small>RISK OF ELECTRIC SHOCK DO NOT OPEN</small> </div> 	<p>CAUTION: TO REDUCE THE RISK OF ELECTRIC SHOCK, DO NOT REMOVE COVER (OR BACK). NO USER-SERVICEABLE PARTS INSIDE. REFER SERVICING TO QUALIFIED SERVICE PERSONNEL.</p>
	<p>The lightning flash with arrowhead symbol, within equilateral triangle, is intended to alert the user to the presence of uninsulated “dangerous voltage” within the product’s enclosure that may be of sufficient magnitude to constitute a risk of electric shock to persons.</p>
	<p>The exclamation point within an equilateral triangle is intended to alert the user to the presence of important operating and maintenance (servicing) instructions in the literature accompanying the appliance.</p>

WARNING: TO PREVENT FIRE OR SHOCK HAZARD, DO NOT EXPOSE THIS APPLIANCE TO RAIN OR MOISTURE.

1. Read these instructions.
2. Keep these instructions.
3. Heed all warnings.
4. Follow all instructions.
5. Do not use this apparatus near water.
6. Clean only with dry cloth.
7. Do not block any ventilation openings. Install in accordance with the manufacturer’s instructions.
8. Do not install near any heat sources such as radiators, heat registers, stoves, or other apparatus (including amplifiers) that produce heat.
9. Do not defeat the safety purpose of the polarized or grounding-type plug. A polarized plug has two blades with one wider than the other. A grounding type plug has two blades and a third grounding prong. The wide blade or the third prong are provided for your safety. If the provided plug does not fit into your outlet, consult an electrician for replacement of the obsolete outlet.
10. Protect the power cord from being walked on or pinched particularly at plugs, convenience receptacles, and the point where they exit from the apparatus.
11. Only use attachments/accessories specified by the manufacturer.
12. Use only with the cart, stand, tripod, bracket, or table specified by the manufacturer, or sold with the apparatus. When a cart is used, use caution when moving the cart/ apparatus combination to avoid injury from tip-over.



13. Unplug this apparatus during lightning storms or when unused for long periods of time.
14. Refer all servicing to qualified service personnel. Servicing is required when the apparatus has been damaged in any way, such as power-supply cord or plug is damaged, liquid has been spilled or objects have fallen into the apparatus, the apparatus has been exposed to rain or moisture, does not operate normally, or has been dropped.
15. The apparatus draws nominal non-operating power from the AC outlet with its POWER or STANDBY/ON switch not in the ON position.
16. The mains plug is used as the disconnect device, the disconnect device shall remain readily operable.

17. If you are experiencing problems with this product, contact TEAC for a service referral. Do not use the product until it has been repaired.

The nameplate is located on the bottom of the unit as shown below.

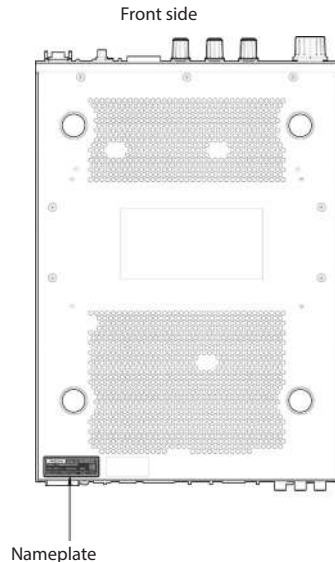

CAUTION

- Do not expose this apparatus to drips or splashes.
- Do not place any objects filled with liquids, such as vases, on the apparatus.
- Do not install this apparatus in a confined space such as a book case or similar unit.
- The apparatus should be located close enough to the AC outlet so that you can easily grasp the power cord plug at any time.

WARNING

Products with Class 1 construction are equipped with a power supply cord that has a grounding plug. The cord of such a product must be plugged into an AC outlet that has a protective grounding connection.

WARNING

This equipment is not suitable for use in locations where children are likely to be present.

For U.S.A.

Supplier's Declaration of Conformity

Model Number: MA-BT240

Trade Name: TASCAM

Responsible party: TEAC AMERICA, INC.

Address: 10410 Pioneer Blvd., Unit #3, Santa Fe Springs, California 90670, U.S.A

Telephone number: 1-323-726-0303



This device complies with Part 15 of the FCC Rules. Operation is subject to the following two conditions: (1) this device may not cause harmful interference, and (2) this device must accept any interference received, including interference that may cause undesired operation.

INFORMATION TO THE USER

This equipment has been tested and found to comply with the limits for a Class B digital device, pursuant to Part 15 of the FCC Rules. These limits are designed to provide reasonable protection against harmful interference in a residential installation. This equipment generates, uses, and can radiate radio frequency energy and, if not installed and used in accordance with the instructions, may cause harmful interference to radio communications. However, there is no guarantee that interference will not occur in a particular installation. If this equipment does cause harmful interference to radio or television reception, which can be determined by turning the equipment off and on, the user is encouraged to try to correct the interference by one or more of the following measures.

- a) Reorient or relocate the receiving antenna.
- b) Increase the separation between the equipment and receiver.
- c) Connect the equipment into an outlet on a circuit different from that to which the receiver is connected.
- d) Consult the dealer or an experienced radio/TV technician for help.

ATTENTION

Changes or modifications to this equipment not expressly approved by TEAC CORPORATION for compliance could void the user's authority to operate this equipment.

IN USA/CANADA, USE ONLY ON 120 V SUPPLY.

For Canada

THIS CLASS B DIGITAL APPARATUS COMPLIES WITH CANADIAN ICES-003.

CET APPAREIL NUMERIQUE DE LA CLASSE B EST CONFORME A LA NORME NMB-003 DU CANADA.

For European Customers

Disposal of electrical and electronic equipment

- (a) All electrical/electronic equipment and waste batteries/accumulators should be disposed of separately from the municipal waste stream via collection facilities designated by the government or local authorities.
- (b) By disposing of electrical/electronic equipment and waste batteries/accumulators correctly, you will help save valuable resources and prevent any potential negative effects on human health and the environment.
- (c) Improper disposal of waste electrical/electronic equipment and batteries/accumulators can have serious effects on the environment and human health because of the presence of hazardous substances in the equipment.
- (d) The crossed out wheeled dust bin symbol  indicates that electrical and electronic equipment must be collected and disposed of separately from household waste.
- (e) The return and collection systems are available to the end users. For more detailed information about disposal of old electrical and electronic equipment, please contact your city office, waste disposal service or the shop where you purchased the equipment.

Wireless equipment precautions

Compliance of radio transmitter and interference

This product has the function of broadband transmitter using 2.4GHz Band.

Use frequency range: 2402 MHz - 2480 MHz

Maximum output power: Bluetooth® Class 2 (less than 2.5 mW) Please use only in the country where you purchased the product. Depending on the country, restrictions on the use of Bluetooth wireless technology might exist.

Model for USA

Labeling of authorization

FCC ID: XEG-MABT240

Model for Canada

Compliance of radio transmitter

This device complies with Innovation, Science and Economic Development Canada's licence-exempt RSSs.

Operation is subject to the following two conditions:

- 1) This device may not cause interference.
- 2) This device must accept any interference, including interference that may cause undesired operation of the device.

Labeling of authorization

IC ID: 1559C-MABT240

Model for EEA (European Economic Area)



Hereby, TEAC CORPORATION declares that the radio equipment type MA-BT240 is in compliance with Directive 2014/53/EU, and the other European Directives, or Commission Regulations.



Hereby, TEAC CORPORATION declares that the radio equipment type MA-BT240 is in compliance with UK Radio Equipment Regulations.

The full text of the EU or UK declaration of conformity is available at the following internet address: Please contact us by e-mail.

<https://tascam.eu/en/contact.html>

Radiation Exposure requirements

This equipment meets the regulation, which is recognized internationally, for the case of human exposure to radio waves generated by the transmitter.

Statement of compliance

Model for USA

This equipment complies with FCC radiation exposure limits set forth for an uncontrolled environment and meets the FCC radio frequency Exposure Guidelines.

Model for Canada

This equipment complies with IC RSS-102 radiation exposure limits set forth for an uncontrolled environment.

Model for EEA (European Economic Area)

This equipment complies with EN 62479; Assessment of the compliance of low power electronic and electrical equipment with the basic restrictions related to human exposure to electromagnetic fields; the harmonised standard of DIRECTIVE 2014/53/EU.

This equipment has very low levels of RF energy that it deemed to comply without maximum permissive exposure evaluation (MPE). But it is desirable that it should be installed and operated keeping the radiator at least 20 cm or more away from person's body (excluding extremities: hands, wrists, feet and ankles).

Contents

IMPORTANT SAFETY INSTRUCTIONS	3
Wireless equipment precautions.....	6
Compliance of radio transmitter and interference	6
Radiation Exposure requirements.....	6
Introduction	8
Features	8
Included items.....	8
Trademarks and copyrights.....	9
Conventions used in this manual	9
Precautions for placement and use	9
Notes about power supplies for US/Canada.....	9
Beware of condensation.....	10
Cleaning the unit	10
About TASCAM customer support service.....	10
Bluetooth® overview	10
Profiles	10
Codecs	10
Content protection.....	10
Transmission security	10
Names and functions of parts	11
Front panel	11
Rear panel	12
Preparation	13
Connecting Euroblock plugs.....	13
Attaching the Bluetooth antenna	13
Elongating the antenna	13
Connections	14
Step 1. Connecting speakers.....	15
For high-impedance connection (240 W × 1ch).....	15
For low-impedance connection (120W × 2ch)	15
Step 2. Connecting other equipment	16
Connecting to music sources	16
Connecting microphones.....	16
Using an external controller	16
Connecting with Bluetooth devices.....	17
Pairing	17
Disconnecting	17
Basic operation	18
Operation 1. Turning the unit on.....	18
Operation 2. Adjusting the volume (mix).....	18
Attaching rack ears.....	19
Using an AK-RM05 (sold separately).....	19
Using an AK-RS1 (sold separately).....	19
Troubleshooting.....	20
Specifications/rated values	21
Speaker output	21
High impedance	21
Low impedance	21
Inputs	21
Mic/line inputs (MIC/LINE IN)	21
Line inputs (LINE IN 1/LINE IN 2)	21
Audio performance	21
Outputs.....	21
Line outputs (LINE OUT)	21
Bluetooth®.....	21
External control (VOL. REMOTE connector for output volume adjustment).....	21
Other.....	21
Dimensional drawings	22

Introduction

Thank you very much for purchasing the TASCAM MA-BT240. Before using this unit, read this Owner's Manual carefully so that you will be able to use it correctly and enjoy working with it for many years. After you have finished reading this manual, please keep it in a safe place for future reference. You can also download this Owner's Manual from the TASCAM website.



MA-BT240

<https://tascam.jp/int/product/ma-bt240/docs>

Features

- Class-D power amp that supports both low-impedance (120 W × 2 ch @ 4Ω/8Ω) and high-impedance (240 W × 1 ch, 100 V/70 V) connection
- Compact form supports both rack mounting and placement on flat surfaces
- Bluetooth® receiver built in
- 2 line inputs
- 1 mic/line input with ducking and paging functions
- Mixing function supported

Included items

This product includes the following items.

Take care when opening the package to avoid damaging the items. Keep the box and packing materials for transportation in the future.

Please contact the store where you purchased this unit if any of these items are missing or have been damaged during transportation.

Main unit × 1

Model for Europe.

Power Cord × 1 3P (CEE7)

Model for USA/Canada.

Power Cord × 1 3P (NEMA 5-15P)

3-prong to 2-prong adapter × 1

Bluetooth antenna × 1

Various Euroblock plugs:

- For speaker output
5.08mm pitch (2 pin) for high impedance × 1
- 5.08mm pitch (4 pin) for low impedance × 1
- 3.81mm pitch (4 pin) for mic input × 1
- 3.81mm pitch (3 pin) for external controller use × 1

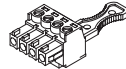
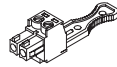

Cable band kit × 1

Rubber feet × 4

Owner's Manual (this document) including warranty × 1

TASCAM ID registration guide × 1

Trademarks and copyrights

- The duplication, broadcast, showing, cable broadcast, public performance and rental (including without charge) of protected content without permission is prohibited by law.
- The Bluetooth® word mark and logos are registered trademarks owned by Bluetooth SIG, Inc. and any use of such marks by TEAC Corporation is under license.
- TASCAM is a registered trademark of TEAC Corporation.
- Other company names, product names and logos in this document are the trademarks or registered trademarks of their respective owners.

Conventions used in this manual

We use the following conventions in this manual.

- As necessary, additional information is provided under TIP, NOTE and CAUTION headings.

TIP

These are tips about how to use the unit.

NOTE

These provide additional explanations and describe special cases.

ATTENTION

Failure to follow these instructions could result in damage to equipment.

⚠ CAUTION

Failure to follow these instructions could result in injury.

Precautions for placement and use

- The guaranteed operating temperature range of this unit is 0–40°C.
- Do not install this unit in the following types of locations. Doing so could make the sound quality worse or cause malfunction.
 - Places with significant vibrations
 - Next to a window or in another location exposed to direct sunlight
 - Near heaters or other extremely hot places
 - Extremely cold places
 - Very humid or poorly ventilated places
 - Very dusty places
- Install the unit so that it is level.
- When placing it on a table or shelf, for example, attach the rubber feet included in the same packaging to the bottom of the unit to provide sufficient airflow. In addition, ensure that there is enough open space (at least 10 cm) behind, above and to the sides of the unit.
- **When mounting this unit in a rack, leave at least 1U between it and other equipment above and below and ensure sufficient airflow. Furthermore, ensure sufficient airflow by covering the open spaces with ventilation panels or leaving them open, for example. If the temperature inside the rack is high, open the back of the rack and keep it at least 10 cm away from walls and the ceiling and ensure ventilation. If the back of the rack cannot be opened, install a fan kit or other ventilation equipment.**

Notes about power supplies for

US/Canada

Insert the included power cord all the way into the AC IN connector.

This unit can be used with AC 100–120V (50/60Hz) power supply voltage.

Hold the power cord by its plug when connecting or disconnecting it.

⚠ CAUTION

- The included power cord has a rated voltage of 125V AC. It cannot be used with over 125 V.
- The 3-prong to 2-prong adapter is for Japan. It is not for use in the USA.

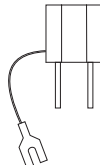

Beware of condensation

Condensation could occur if the unit is moved from a cold place to a warm place, it is used immediately after a cold room has been heated or it is otherwise exposed to a sudden temperature change. To prevent this, or if this occurs, let the unit sit for one or two hours at the new room temperature before using it.

Cleaning the unit

Use a dry soft cloth to wipe the unit clean. Do not wipe with chemical cleaning cloths, thinner, alcohol or other chemical agents. Doing so could damage the surface or cause discoloration.

About TASCAM customer support service

TASCAM products are supported and warranted only in their country/region of purchase.

To receive support after purchase, on the TASCAM Distributors list page of the TEAC Global Site (<https://teac-global.com/>), search for the local company or representative for the region where you purchased the product and contact that organization. When making inquiries, the address (URL) of the shop or web shop where it was purchased and the purchase date are required. Moreover, the warranty card and proof of purchase might also be necessary.

Bluetooth® overview

This unit has a built-in Bluetooth 5.1 audio receiver, and can output sound played on a computer or portable audio device that supports Bluetooth (Bluetooth device).

ATTENTION

The Bluetooth function of this unit is not guaranteed to enable connection or operation with all Bluetooth devices.

Profiles

This unit supports the following Bluetooth profiles.

- A2DP (Advanced Audio Distribution Profile)
- AVRCP (Audio/Video Remote Control Profile)

In order to transfer audio by Bluetooth, the Bluetooth device must support A2DP.

In order to control playback on the Bluetooth device, it must support AVRCP.

Even if a Bluetooth device supports the same profiles, though, its functions might differ according to its specifications.

Codecs

This unit supports the following A2DP codecs. It will automatically select one of them during audio transfer.

- SBC
- AAC

The unit will select the appropriate A2DP codec to use according to the codec compatibility of the other Bluetooth device and communication conditions.

NOTE

- The A2DP codec to be used cannot be selected by pressing a button, for example.
 - Due to characteristics of Bluetooth wireless technology, playback from a Bluetooth device will be slightly delayed compared to playback from this unit.
-

Content protection

This unit supports SCMS-T as a form of content protection when transmitting audio, so it can play protected audio.

Transmission security

This unit supports security functions during Bluetooth transmission in accordance with the Bluetooth standard specifications, but it does not guarantee the privacy of such transmissions.

TEAC Corporation will bear no responsibility should an information leak occur during transmission by Bluetooth.

Names and functions of parts

⚠ CAUTION

Turn off the power to this unit or minimize the volume before changing the switch settings on this unit.

Front panel

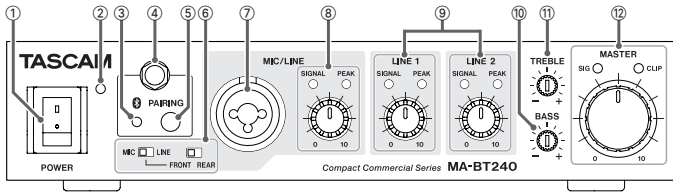

- ① **POWER switch**
Press to turn the unit on and off.
The POWER indicator lights when the unit is on.
- ② **POWER indicator***
This shows the status of the unit.
When the POWER switch on the unit is turned on, the POWER indicator lights green.
("The POWER indicator is blinking orange and sound is not output" on page 20)
- ③ **Bluetooth indicator***
This blinks while pairing and stays lit when connected.
- ④ **Bluetooth antenna connector**
Connect the included Bluetooth antenna here.
- ⑤ **Bluetooth PAIRING button**
Use this button to pair with Bluetooth devices.
("Connecting with Bluetooth devices" on page 17)
- ⑥ **MIC/LINE settings**
Use these to make MIC/ LINE input settings.
FRONT/REAR switch
This selects whether to use the MIC/LINE jack on the front or the MIC/LINE IN connector on the back of the unit as the MIC/LINE input.
("Connecting microphones" on page 16)
MIC/LINE switch
This changes the level input to the MIC/LINE jack.
("Connecting microphones" on page 16)
- ⑦ **MIC/LINE jack**
This balanced MIC/LINE input is an XLR/TRS combo jack.
XLR (1: GND, 2: HOT, 3: COLD)
TRS (Tip: HOT, Ring: COLD, Sleeve: GND)
 - Condenser mics cannot be used with this.
- ⑧ **MIC/LINE knob**
This adjusts the volume of the connector selected by the FRONT/REAR switch. The indicators show the status.
SIGNAL indicator*
This lights when the input signal exceeds a certain level.
PEAK indicator*
This lights when the signal is about to distort.
 - If this lights, turn the knob counterclockwise to reduce the volume.
- ⑨ **LINE 1 / LINE 2 knobs**
These adjust the volumes of the LINE 1 and LINE 2 input jacks.
SIGNAL indicators*
These light when the signals input to the LINE 1 / LINE 2 input jacks exceed a certain level.
PEAK indicators*
These light when the signals input to the LINE 1 / LINE 2 input jacks are about to distort.
 - If this lights, turn the knob counterclockwise to reduce the volume.
- ⑩ **BASS knob**
This adjusts the low frequencies of signals output from the speakers. The center position is the standard level. Turn it counterclockwise to reduce and clockwise to increase the volume of low frequencies.
NOTE
Use a small flathead screwdriver to adjust this.
- ⑪ **TREBLE knob**
This adjusts the high frequencies of signals output from the speakers. The center position is the standard level. Turn it counterclockwise to reduce and clockwise to increase the volume of high frequencies.
NOTE
Use a small flathead screwdriver to adjust this.
- ⑫ **MASTER knob**
This adjusts the volume output from the speakers. Turn this clockwise to increase the volume. Turn it completely counterclockwise to minimize the volume output.
SIG indicator*
This lights when the output signal exceeds a certain level.
CLIP indicator*
This lights when the signal output to the speakers exceeds a set value.
The internal limiter will operate when this happens.
 - If this lights, turn the MASTER knob counterclockwise to reduce the volume.

* See Basic operation page 18 for details about indicator lighting states.

Rear panel

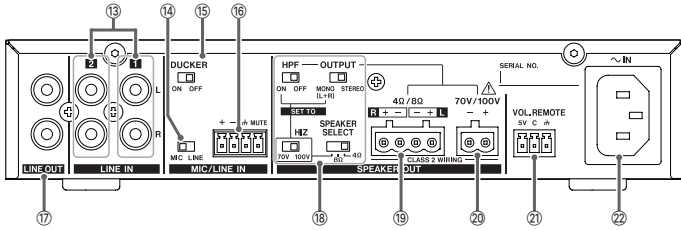

13 **LINE IN 1/2 jacks**

These are unbalanced RCA stereo input jacks.

Use these to connect CD players, portable music players and other devices.

Use the LINE 1 and LINE 2 knobs on the front of the unit to adjust their volume levels.

14 **MIC/LINE switch**

This changes the level input to the MIC/LINE IN on the rear panel.

("Connecting microphones" on page 16)

15 **DUCKER switch**

If this is set to ON, other input signals will be automatically attenuated during mic input.(ducking function).

This can make announcements clearer.

16 **MIC/LINE IN connector**

This is a balanced Euroblock mic/line input connector.

- By connecting the talk switch of a paging mic to the MUTE terminal, the volumes of input signals other than the mic input can be attenuated.
("Connecting microphones" on page 16)

17 **LINE OUT jacks**

These are unbalanced RCA stereo output jacks.

Use these to output signals to the line input connectors of other devices.

The signals output are a mix of the signals input from the MIC/LINE (front) or MIC/LINE IN (back) with those from the LINE IN 1 and LINE IN 2.

- The BASS, TREBLE and MASTER knobs as well as external controller settings do not affect the LINE OUT output.

18 **SPEAKER OUT settings
SPEAKER SELECT switch**

Amp output can be set to high (HIZ) or low (4Ω, 8Ω) impedance.

HIZ (Hi-Z) switch

When using high impedance connection, the output voltage can be switched between 70V and 100V.

("For high-impedance connection (240 W × 1ch)" on page 15)

HPF switch

This activates the high pass filter.

ATTENTION

To prevent saturation of the speaker transformer, always set this to ON when using high impedance connection,

OUTPUT switch

This switches the output format to mono or stereo.
("Step 1. Connecting speakers" on page 15)

19 **SPEAKER OUT 4Ω/8Ω terminals**

These speaker outputs are for low-impedance connection.
("For low-impedance connection (120W × 2ch)" on page 15)

20 **SPEAKER OUT 70V/100V terminals**

These speaker outputs are for high-impedance connection.
("For high-impedance connection (240 W × 1ch)" on page 15)

CAUTION

Do not touch the SPEAKER OUT 70V/100V terminals while the amplifier is switched on, that may result in an unpleasant sensation. All connections should be made with the amplifier switched off and the mains cable removed.

21 **VOL. REMOTE connector**

Use this connector to connect an external controller. An external controller can be used to adjust the MASTER volume of this unit.
("Using an external controller" on page 16)

22 **AC IN connector**

Connect the included power cord here.
("Notes about power supplies for US/Canada" on page 9)

Preparation

Connecting Euroblock plugs

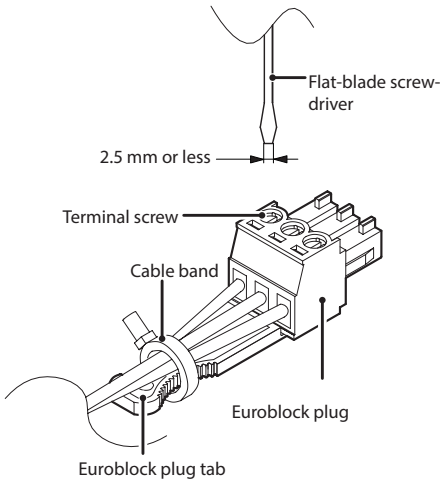

1. Loosen the Euroblock plug terminal screws.

NOTE

Use a flat-blade screwdriver with a width of 2.5mm or less.

2. Insert wires.

NOTE

The wires that are compatible with the included Euroblock plugs are AWG12–AWG22 for speaker output and AWG16–AWG28 for mic input and REMOTE. Using wires within the compatible range, trim about 7 mm of the protective sheaths from their ends.

3. Tighten the Euroblock plug terminal screws.

NOTE

Confirm that the wires cannot be pulled out.

4. Use an included wire band to attach the wires to the Euroblock plug tab.

Attaching the Bluetooth antenna

Before connecting to a Bluetooth device, follow these procedures to attach the included Bluetooth antenna.

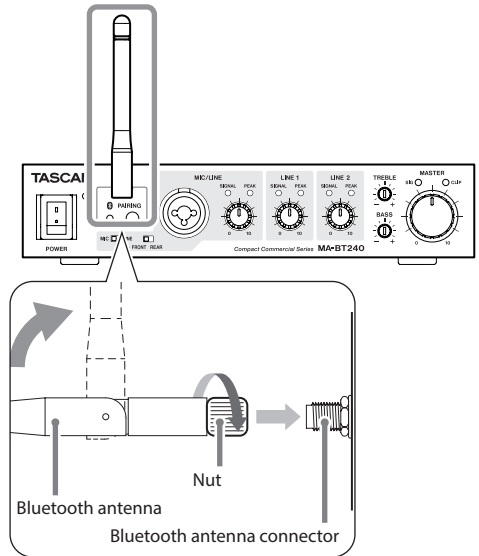

1. Attach the included Bluetooth antenna to the Bluetooth antenna connector.
2. Turn the Bluetooth antenna nut to secure it to the antenna connector.
3. Raise the Bluetooth antenna.

ATTENTION

- Use the included antenna, which was designed for use with the MA-BT240.
- Be careful to bend the antenna in the correct direction.
- Do not forcefully bend the antenna.

Elongating the antenna

The antenna can be elongated by using a commercially-available cable with an RP-SMA connector.

- For the antenna cable, use one with 50Ω impedance that is 20 m or less.

ATTENTION

Even when elongating the antenna, use the included one, which was designed for use with the MA-BT240.

Connections

CAUTION

- Always confirm that the power to the unit is off before connecting speakers. If on, there is danger of electric shock.

ATTENTION

- When connecting other equipment, confirm that the power is off to devices being connected to this unit. Also confirm that the volume knobs for the inputs being used and the MASTER are at 0 (turned completely counterclockwise).
- Always match the impedance settings of this unit and the speakers. Use without matching could damage this unit and the speakers.
- Install the speaker cables so that there is no load on them.

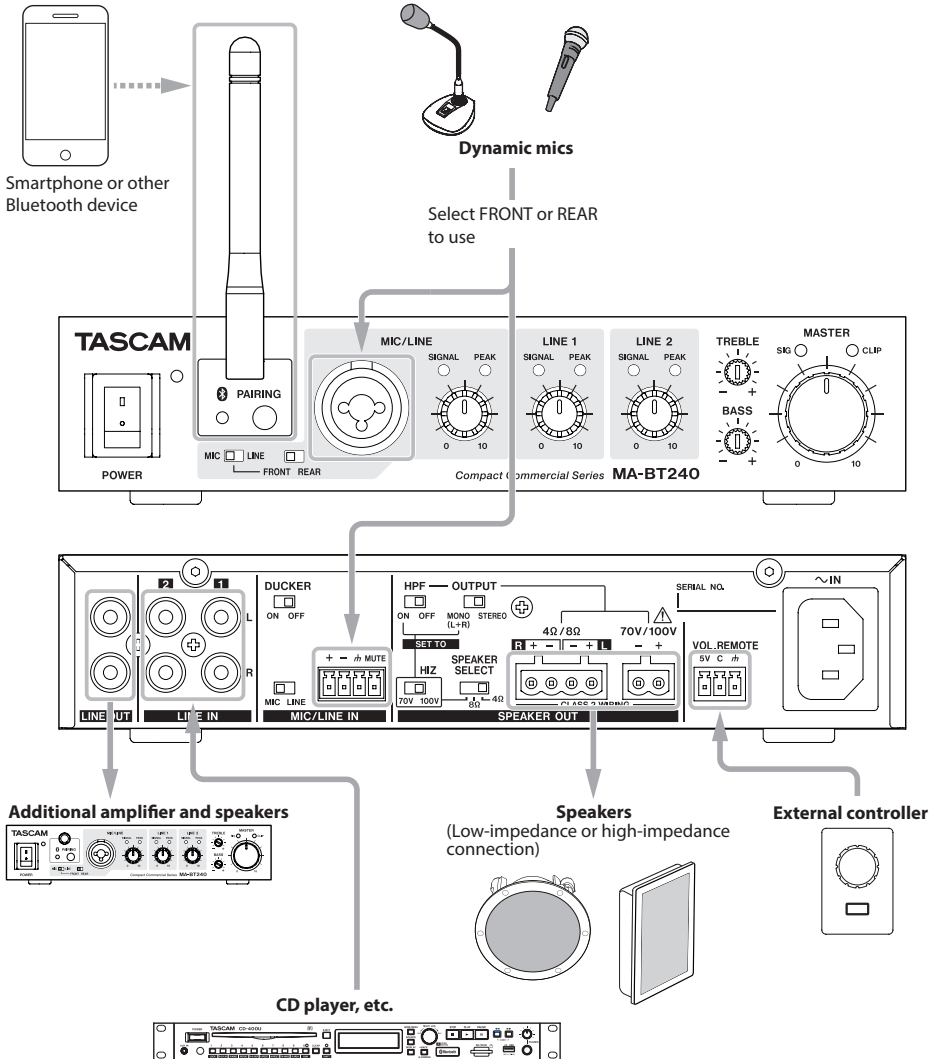

Step 1. Connecting speakers

For high-impedance connection (240 W × 1ch)

1. Set SPEAKER SELECT to HiZ.
Set the output voltage to 70V or 100V according to the setup in use.

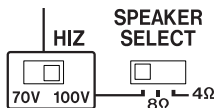

NOTE

When using a high-impedance connection, it will operate with output voltage of 100V or 70V. 100V is usual in Japan and Europe, while 70V is usual in the USA. Since it has less voltage drop than 70V, 100V is superior for long-distance transmission.

2. Set HPF (high-pass filter) to ON and OUTPUT to MONO.

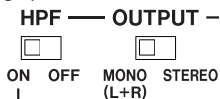

ATTENTION

Always set HPF to ON because a speaker transformer could become saturated and the protective circuit of this unit could be activated.

NOTE

If OUTPUT is set to STEREO during high-impedance connection, only sound from the L channel will be output from the speaker output. Always set it to MONO.

3. Connect to the SPEAKER OUT 70V/100V + and - terminals. Use the included 5.08mm pitch (2pin) Euroblock for connection.

ATTENTION

Do not exceed 240 W total for the rated input of the connected speakers.

For low-impedance connection (120W × 2ch)

1. Set SPEAKER SELECT to 4Ω or 8Ω to match the connected speakers.

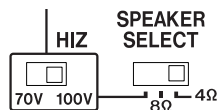

2. Set OUTPUT to STEREO or MONO to select the output format. When MONO is selected, the same sound (L+R) will be output from both left and right.

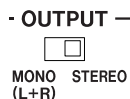

3. Connect to the SPEAKER OUT 4Ω/8Ω L/R + and - terminals. Use the included 5.08mm pitch (4pin) Euroblock for connection.

ATTENTION

- When connecting multiple speakers, be sure that the composite impedance equals or exceeds the impedance set on this unit.
- Do not connect low-impedance speakers to the high-impedance terminals.

Step 2. Connecting other equipment

⚠ CAUTION

When connecting other equipment, confirm that the power is off to devices being connected to this unit. Also confirm that the volume knobs for the inputs being used and the MASTER are at 0 (turned completely counterclockwise).

Connecting to music sources

Connect CD players, portable music players and similar devices to the LINE IN 1 and LINE IN 2 RCA jacks.

Connecting microphones

1. Connect mics to the MIC/LINE connectors on the front and rear of the unit.
When using a dynamic mic (with an XLR or TRS cable), use the MIC/LINE jack on the front.

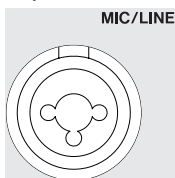

When using a wireless mic receiver or another device that is fixed in place use the MIC/LINE IN connector on the rear.

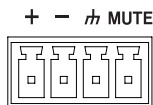

Use the included 3.81mm pitch (4 pin) Euroblock for connection when connecting to the MIC/LINE IN connector on the rear panel.

- When connecting the talk switch of a paging mic, wire it so that the MUTE connector and the M terminal are connected when the talk switch is pressed.
2. Set the connector used and the input level.
When using the MIC/LINE input on the front, set the switch to FRONT. Set the switch to MIC or LINE according to the level of the connected equipment.



When using the MIC/LINE input on the rear, set the switch to REAR. Set the switch on the rear to MIC or LINE according to the level of the connected equipment.

FRONT/REAR switch on the front panel



MIC/LINE switch on the rear panel



Using an external controller

If a volume control (10k Ω B curve) is connected to the VOL. REMOTE connector, the volume can be adjusted from a remote location.
Use the included 3.81mm pitch (3 pin) Euroblock for connection.

- The volume will become louder when the terminal C voltage increases.

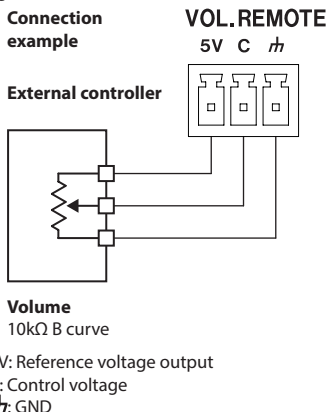

Procedures for suitable volume adjustment

1. Maximize the level of the volume connected to the VOL. REMOTE connector.
2. Adjust the MASTER volume on this unit to the necessary maximum volume.
3. Adjust to the desired level with the volume connected to the VOL. REMOTE connector.

The range that can be adjusted with the external controller volume is the maximum volume range set with the MASTER volume of this unit

Connecting with Bluetooth devices

Connect the included antenna to the front panel in order to use Bluetooth.

Pairing

1. Press the PAIRING button on the front panel for at least two seconds.
The indicator to the side of the PAIRING button will blink while pairing.
2. Operate the Bluetooth device to be connected to this unit.
 - Refer to the operation manual of that Bluetooth device for connection procedures.
 - The indicator stays lit when connected to a Bluetooth device.
3. Operate the connected Bluetooth device and adjust the volume.
 - When a Bluetooth device is connected, playback will be paused. After adjusting the Bluetooth device volume, start playback.
 - Bluetooth volume cannot be adjusted by itself with this unit.
Adjust the volume on the Bluetooth device.

ATTENTION

Bluetooth is designed to send playback pause commands using AVRCP basic commands.

However, this does not guarantee operation with all devices.

When a Bluetooth device is connected, minimize volume of the MASTER knobs and the the Bluetooth device beforehand.

NOTE

When this unit is turned on, it will automatically try to connect with the Bluetooth device to which it was previously connected.

At this time, connection will automatically be canceled if connection is not possible because that Bluetooth device is not turned on or its Bluetooth function is turned off.

Disconnecting

The Bluetooth device that is currently connected can be disconnected from the unit.

1. Press the PAIRING button for at least two seconds.
2. This ends the connection. The indicator will start blinking and the unit will be ready to connect.

NOTE

- After about two minutes pass, the indicator will become unlit and Bluetooth will turn off.
- Pressing the PAIRING button for at least two seconds while the indicator is blinking will make it become unlit and turn off Bluetooth.

Basic operation

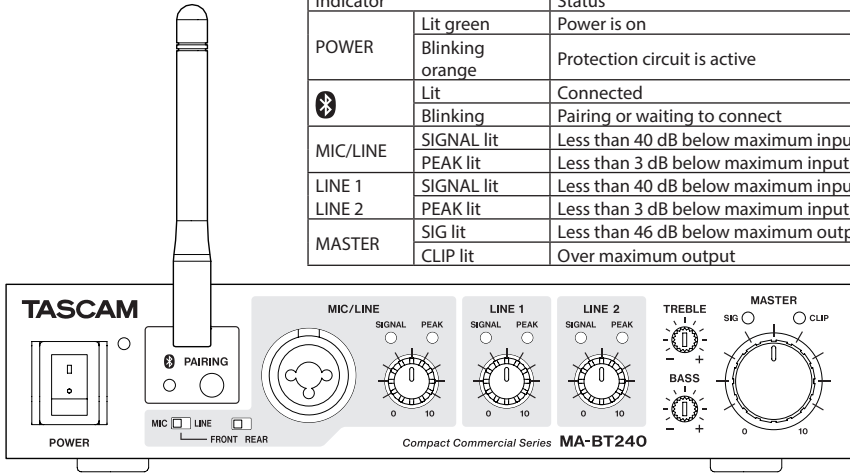

Indicator	Status	
POWER	Lit green	Power is on
	Blinking orange	Protection circuit is active
Bluetooth	Lit	Connected
	Blinking	Pairing or waiting to connect
MIC/LINE	SIGNAL lit	Less than 40 dB below maximum input level
	PEAK lit	Less than 3 dB below maximum input level
LINE 1	SIGNAL lit	Less than 40 dB below maximum input level
	PEAK lit	Less than 3 dB below maximum input level
LINE 2	SIGNAL lit	Less than 40 dB below maximum input level
	PEAK lit	Less than 3 dB below maximum input level
MASTER	SIG lit	Less than 46 dB below maximum output level
	CLIP lit	Over maximum output

Operation 1. Turning the unit on

1. Confirm that the power switches are off on all devices connected to this unit.
2. Confirm that the MASTER knob is set to 0 (turned completely counterclockwise).

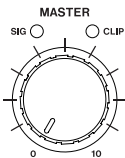

3. Connect the included power cord to the AC IN connector and insert the power plug in an outlet.
4. Turn on the power to the connected devices before turning this unit on.

ATTENTION

- The output from the LINE OUT jacks on the rear panel are affected by the settings of the MIC/LINE, LINE 1 and LINE 2 knobs, but not by the MASTER knob.
- When adjusting the volume, minimize the settings of the MIC/LINE, LINE 1 and LINE 2 knobs beforehand.

NOTE

When turning off the power, turn off this unit before turning off connected devices.

Operation 2. Adjusting the volume (mix)

1. Adjust the MASTER knob so that the speaker volume is low.

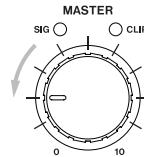

Adjust this again as necessary while conducting the following procedures to prevent the volume from becoming too loud.

2. Turn the volume knobs for each input to adjust their volumes. Input audio signals through the inputs being adjusted, and adjust them so that their SIGNAL indicators light but their PEAK indicators do not light.

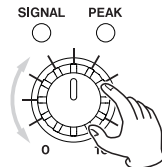

NOTE

To adjust the Bluetooth volume, adjust it on the Bluetooth device.

TIP

Adjusting the balance is easier if the volume of the main channel is adjusted first, followed by the volumes of the remaining channels.

3. Adjust the MASTER knob to set the desired volume.

Attaching rack ears

Rack ears (sold separately) must first be attached before mounting this unit in a rack. Refer to the illustrations below when attaching them.

ATTENTION

In addition to removing the rubber feet from the unit, be sure to leave at least 1U space open between this and other devices above and below.

Using an AK-RM05 (sold separately)

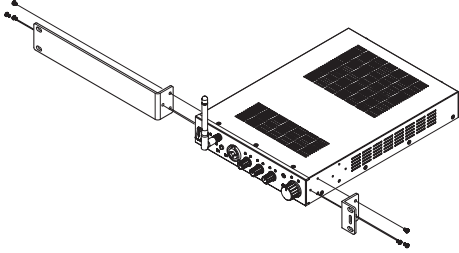

When mounting two units, attach a bottom plate to connect them.

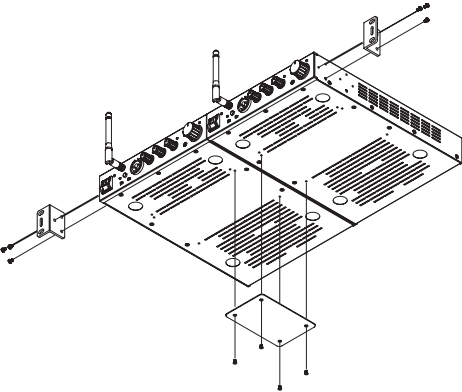

Using an AK-RS1 (sold separately)

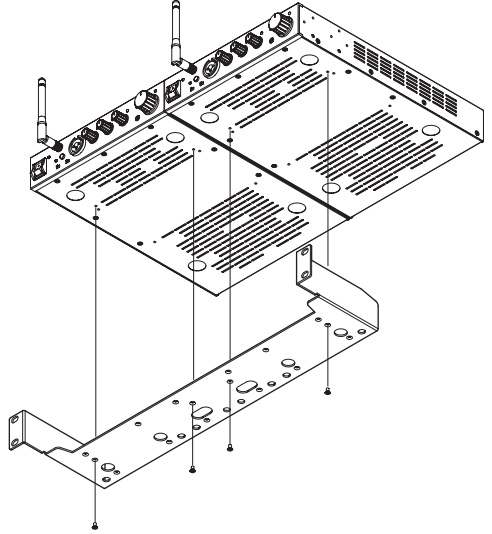

NOTE

The attachment holes in rackmount ears are elongated, allowing adjustment so that the unit does not stick out of the rack when attached.

Troubleshooting

If you are having trouble with the operation of this unit, please try the following before seeking repair. If these measures do not solve the problem, please contact the store where you purchased this unit or TASCAM customer support service.

The unit will not turn on

Confirm that the power plug and other connectors are inserted completely.

The POWER indicator is blinking orange and sound is not output

- The protection circuit is active.
Turn the POWER switch off and leave it in a place with good ventilation for several minutes before turning the power on again.
Install this unit in a location that does not easily become hot.
If that does not resolve the issue, confirm that a short is not occurring with a speaker output.
- Confirm that this unit is not set to high impedance when low-impedance speakers are connected.
If connecting multiple speakers when this unit is set to low impedance, confirm that the composite impedance is not lower than the impedance set on this unit.

The sound distorts

- If the CLIP indicator lights, turn the MASTER knob to lower the volume.
- If a PEAK indicator lights for any input, turn its volume knob to lower the volume.
- Lower the output volume of the paired Bluetooth device.
- Too much EQ could be the problem. Set the TREBLE and BASS to their center positions.

The volume is low even when the MASTER knob is turned up

- Make volume adjustments (mix) again.
("Operation 2. Adjusting the volume (mix)" on page 18)
- Confirm that this unit is not set to low impedance when high-impedance speakers are connected.
- Confirm that the MIC/LINE switch is not set to LINE even though a mic is connected.

MIC/LINE sound is not output

This unit has FRONT/REAR and MIC/LINE input selections. Check these switches again to confirm that they are set correctly.

Cannot pair with another Bluetooth device

- Confirm that the other Bluetooth device supports A2DP.
- Confirm that the other Bluetooth device is in a state that allows transmission. For details, check the operation manual of that Bluetooth device.
- Turn the power off for both this unit and the other Bluetooth device once, turn them both on again and try pairing them.
- Confirm that the other Bluetooth device is not too far away.
Are there walls or other obstacles, for example, between this unit and the other Bluetooth device?
Try changing the positions of this unit and the other Bluetooth device.

Specifications/rated values

Speaker output

High impedance

Rated output	240 W × 1 ch (70 V/100 V)
Composite impedance	
When 100V output voltage	42 Ω or higher
When 70V output voltage	21 Ω or higher
Connector	5.08mm pitch (2 pin) Euroblock

Low impedance

SPEAKER SELECT: 4Ω	
Load impedance	4 Ω or higher
Rated output	120 W × 2 ch (4Ω @ 1kHz, 1%THD)
SPEAKER SELECT: 8Ω	
Load impedance	8 Ω or higher
Rated output	120 W × 2 ch (8Ω @ 1kHz, 1%THD)
Connector	5.08mm pitch (4 pin) Euroblock

Inputs

Mic/line inputs (MIC/LINE IN)

Connectors	
Front	Combo jack (balanced) ¹
Rear	Euroblock (balanced) 3.81mm pitch (4 pin)
MIC selected	
Maximum input level	-30 dBu
Minimum input level	-65 dBu
Input impedance	2 kΩ or more
LINE selected	
Maximum input level	+20 dBu
Nominal input level	+4 dBu
Input impedance	10 kΩ or more

Line inputs (LINE IN 1/LINE IN 2)

Connectors	RCA pin jacks (unbalanced)
Maximum input level	+6.0 dBV
Nominal input level	-10.0 dBV
Input impedance	10 kΩ or more

Audio performance

Frequency response	20 Hz to 20 kHz +2 dB/-2 dB (LINE IN 1 to SPEAKER OUT, 1/8 rated output, TREBLE/BASS flat)
Distortion	0.05% or less (LINE 1 to SPEAKER OUT, 1kHz, at 1/8 rated output)

S/N ratio	92 dB or more (LINE IN 1 to SPEAKER OUT, 1kHz, at rated output)
Crosstalk	70 dB or more (LINE IN 1 to SPEAKER OUT, 1kHz, at rated output)

Outputs

Line outputs (LINE OUT)

Connectors	RCA pin jacks (unbalanced)
Maximum output level	+6.0 dBV
Nominal output level	-10 dBV
Output impedance	200 Ω

Bluetooth®

Version	5.1
Output class	Class 2 (About 10m unobstructed transmission range ²)
Supported profiles	A2DP, AVRCP
Codecs	SBC, AAC

External control

(VOL. REMOTE connector for output volume adjustment)

Connector	3.81mm pitch (3 pin) Euroblock (1: Vcc 5V, 2: Control, 3: GND)
-----------	---

Other

Power supply	
Model for Europe.	AC 220-240 V, 50/60 Hz
Model for USA/Canada.	AC 100-120 V, 50/60 Hz
Cooling method	Natural air cooling
Guaranteed operating temperature range	0°C - 40°C
Guaranteed operating humidity range	5% - 85% (no condensation)
Power consumption	58 W (1/8 power @ all channels driven)
When idle	18 W
Dimensions	214 (W) × 44 (H) × 298 (D) mm (excluding protrusions and Bluetooth antenna)
Weight	2.5kg

- 1 XLR-3-31 equivalent (1: GND, 2: HOT, 3: COLD), 6.3mm (1/4") standard TRS jack (Tip: HOT, Ring: COLD, Sleeve: GND)
- 2 Transmission distance is an estimate. The transmission distance may vary depending on the surrounding environment and radio wave conditions.

- 0 dBu = 0.775 Vrms
- 0 dBV = 1 Vrms

Dimensional drawings

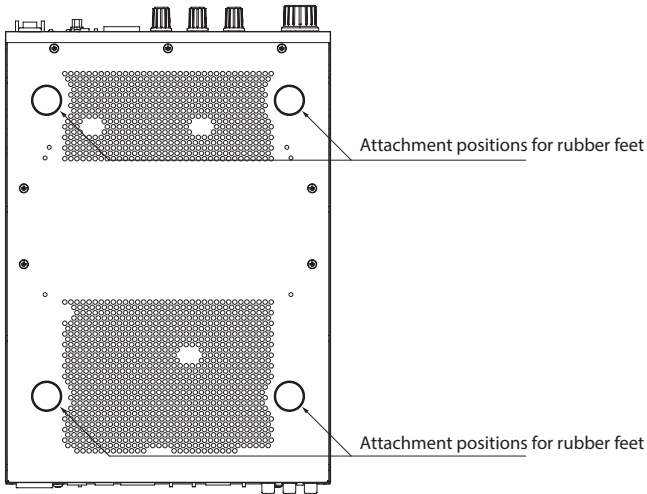
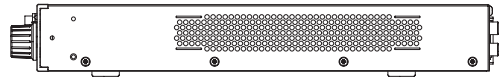
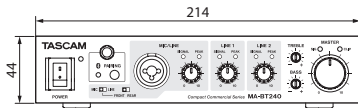
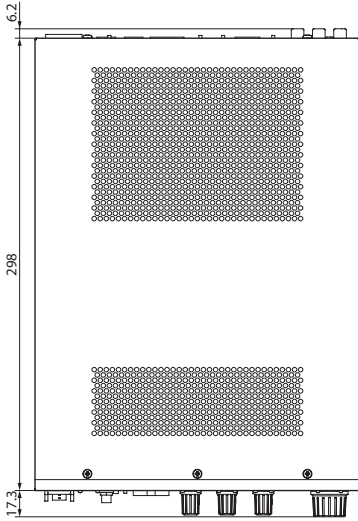

- Illustrations in this manual might differ in part from the actual product.
- Specifications and external appearance might be changed without notification to improve the product.

Block diagram/Schéma fonctionnel/Diagrama de bloques/Blockschaltbild/ Schema a blocchi/ブロックダイアグラム

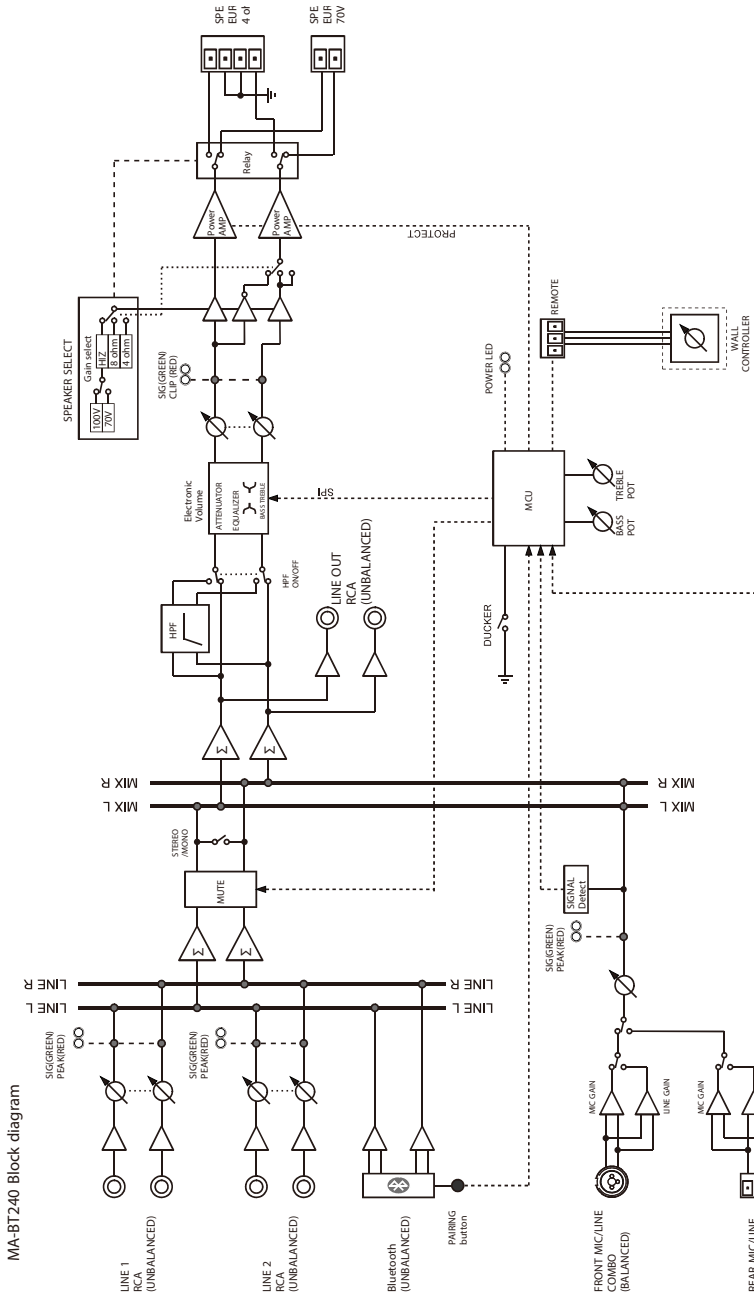

WARRANTY / 保証書

< In the United States >

This warranty gives you specific legal rights and you may also have other rights which vary from state to state. This warranty is only valid within the country the unit was originally purchased.

WHAT IS COVERED AND WHAT IS NOT COVERED

Except as specified below, this warranty covers all defects in materials and workmanship in this product. The following are not covered by the warranty:

1. Damage to or deterioration of the external cabinet.
2. Damage resulting from accident, misuse, abuse or neglect.
3. Damage resulting from failure to perform basic daily maintenance and/or calibration or otherwise resulting from failure to follow instructions contained in your owner's manual.
4. Damage occurring during shipment of the product. (Claims must be presented to the carrier)
5. Damage resulting from repair or attempted repair by anyone other than TEAC or an authorized TASCAM service station.
6. Damage resulting from causes other than product defects, including lack of technical skill, competence, or experience of the user.
7. Damage to any unit which has been altered or on which the serial number has been defaced, modified or is missing.

WHO IS COVERED UNDER THE WARRANTY

This warranty may be enforced only by the original purchaser. This warranty is not valid if the product was purchased through an unauthorized dealer.

LENGTH OF WARRANTY

All parts except heads and disk drives are warranted for one (1) year from the date of original purchase. Heads and disk drives are warranted for ninety (90) days from date of original purchase. Labor is warranted for ninety (90) days from date of original purchase.

WHAT WE WILL PAY FOR

We will pay all labor and material expenses for items covered by the warranty. Payment of shipping charges is discussed in the next section of this warranty.

HOW YOU CAN GET WARRANTY SERVICE

Your unit must be serviced by an authorized TASCAM service station in the United States. (This warranty is not enforceable outside the U.S.) If you are unable to locate an authorized TASCAM service station in your area, please contact us. We either will refer you to an authorized service station or instruct you to return the unit to the factory. Whenever warranty service is required, you must present a copy of the original dated sales receipt from an Authorized TASCAM Dealer.

You must pay any shipping charges if it is necessary to ship the product to service. However, if the necessary repairs

are covered by the warranty, we will pay return surface shipping charges to any destination within the United States.

LIMITATION OF IMPLIED WARRANTIES
Any implied warranties, INCLUDING WARRANTIES OF MERCHANTABILITY AND FITNESS FOR A PARTICULAR PURPOSE, are limited in duration to the length of this warranty.

EXCLUSION OF DAMAGES

TEAC's liability for any defective product is limited to repair or replacement of the product, at TEAC's option. TEAC shall not be liable for:

1. Damages based upon inconvenience, loss of use of the product, loss of time interrupted operation or commercial loss; or
2. Any other damages, whether incidental, consequential or otherwise.

Some states do not allow limitations on how long an implied warranty lasts and/or do not allow the exclusion or limitation of incidental or consequential damages, so the above limitations and exclusions may not apply to you.

To locate an Authorized Service Center in Your Area

CALL 1-323-726-0303

< Europe >

This product is subject to the legal warranty regulations of the country of purchase. In case of a defect or a problem, please contact the dealer where you bought the product.

Ce produit est sujet aux réglementations concernant la garantie légale dans le pays d'achat. En cas de défaut ou de problème, veuillez contacter le revendeur chez qui vous avez acheté le produit.

Las condiciones de garantía de este aparato están sujetas a las disposiciones legales sobre garantía del país en el que ha sido adquirido. En caso de garantía, debe dirigirse al establecimiento donde adquirió el aparato.

Dieses Gerät unterliegt den gesetzlichen Gewährleistungsbestimmungen des Landes, in dem es erworben wurde. Bitte wenden Sie sich im Gewährleistungsfall an den Händler, bei dem sie das Gerät erworben haben.

Questo apparecchio è conforme alle norme sulla garanzia vigenti nel rispettivo Paese in cui esso è stato acquistato. Si prega di rivolgersi al proprio commerciante, presso il quale è stato acquistato l'apparecchio, nel caso in cui si voglia richiedere una prestazione in garanzia.

<日本>

無料修理規定

1. 取扱説明書、本体貼付ラベルなどの注意書きにしたがった正常な使用状態で保証期間内に故障が発生した場合には、ティアック修理センターが無料修理致します。
2. 本体の保証期間は、お買い上げの日から1年です。
3. 保証期間内に故障して無料修理を受ける場合は、本書をご提示の上、ティアック修理センターまたはお買い上げの販売店に

修理をご依頼ください。商品を送付していただく場合の送付方法については、事前にティアック修理センターにお問い合わせください。無償修理の対象は、お客様が日本国内において購入された日本国内向け当社製品に限定されます。

4. ご転居、ご購入品などでお買い上げの販売店に修理をご依頼にならない場合は、ティアック修理センターにご連絡ください。
5. 次の場合には、保証期間内でも有料修理となります。

- (1) ご使用上の誤りおよび不当な修理や改造による故障および損傷
- (2) お買い上げ後の輸送・移動・落下などによる故障および損傷
- (3) 火災、地震、水害、落雷、その他の天災地変、公害や異常電圧による故障および損傷
- (4) 接続している他の機器に起因する故障および損傷
- (5) 業務上の長時間使用など、特に苛酷な条件下において使用された場合の故障および損傷
- (6) メンテナンス
- (7) 本書の提示がない場合
- (8) 本書にお買い上げ年月日、お客様名、販売店名(印)の記入のない場合、あるいは字句を書き換えられた場合

6. 本書(日本語記載部)は日本国内においてのみ有効です。

These warranty provisions in Japanese are valid only in Japan.

7. 本書は再発行致しませんので、紛失しないよう大切に保管してください。

* この保証書は、本書に明示した期間・条件のもとにおいて無料修理をお約束するものです。この保証書によって保証書を発行しているもの(保証責任者)、およびそれ以外の事業者に対するお客様の法律上の権利を制限するものではありません。保証期間経過後の修理などについてはご不明の場合は、ティアック修理センターにお問い合わせください。

この保証書は、本書記載内容で無料修理を行うことをお約束するものです。お買い上げの日から保証期間中に故障が発生した場合は、本書をご提示の上、取扱説明書に記載のティアック修理センターまたはお買い上げの販売店に修理をご依頼ください。

< In other countries/areas >

This warranty gives you specific legal rights, and you may also have other rights that vary by country, state or province.

If you have a warranty claim or request, please contact the dealer where you bought the product.

该保证书赋予了顾客特定的合法权利，并且因国家、州或省等地域的不同，顾客可能拥有其他权利。如需申请或要求保修，请与购买本产品的销售店进行联系。

If you require repair services for your TASCAM equipment, please contact the dealer where the product was purchased from or the TASCAM Distributor in your country. A list of TASCAM Distributors can be found on our website at: <https://teac-global.com/>

WARRANTY / 保証書

Model / Modèle / Modell /
Modello / Modelo / 型名

Owner's name / Nom du propriétaire / Name des Eigentümers /
Nome del proprietario / Nombre del propietario / お名前

MA-BT240

Serial No. / No de série / Seriennummer /
Numero di serie / Número de serie / 機番

Address / Adresse / Adresse /
Indirizzo / Dirección / ご住所

Date of purchase / Date de l'achat / Datum des Kaufs /
Data dell'acquisto / Fecha de compra / お買い上げ日

Dealer's name / Nom du revendeur / Name des Händlers /
Nome del commerciante / Nombre del establecimiento / 販売店名

Sample

TASCAM

<https://teac-global.com/>

Dealer's address / Adresse du revendeur / Adresse des Händlers /
Indirizzo del commerciante / Dirección del establecimiento / 販売店住所

Memo / 修理メモ

お客様にご記入いただいた保証書の控えは、保証期間内のサービス活動およびその後の安全点検活動のために記載内容を利用させていただきます。ご了承ください。

ティアック株式会社

〒206-8530 東京都多摩市落合1-47

ティアック修理センター

〒358-0026 埼玉県入間市小谷田858
電話: 04-2901-1033 / 0570-000-501

TEAC AMERICA, INC.

10410 Pioneer Blvd., Unit #3, Santa Fe Springs, California 90670, U.S.A
Phone: +1-323-726-0303